



OPERATION MANUAL

2200 SERIES

Portable Radio Alarms

MODELS

PC2214 – Wireless 4 Channel, three zones with exit/entrance delay

PC2234 – Wireless 4 Channel, three zones with exit/entrance delay and invisible light beam
WLDX Sensors and Wireless Receiver

COPYRIGHT 2005 KARAS TECHNICAL SERVICES

ALL RIGHTS RESERVED

PUBLICATION NUMBER KTS-111005

FIFTH EDITION



KARAS TECHNICAL SERVICES

P.O. Box 695, Aptos, CA 95001 (831) 685-0816 Fax (831) 685-0817
web site: www.karastech.com

SENTINEL 2200 SERIES OPERATION MANUAL

TABLE OF CONTENTS

1.0 GENERAL DESCRIPTION	
1.1 Basic Operation	1
1.2 Familiarization and Initial Check Out	2
1.3 Operation and Recording Controls, Switches and other Functions	2
1.4 Indicators	3
1.5 Input Jacks	4
1.6 Power Supply	5
1.7 Radio Connections and Antenna	6
1.8 Panel Access	6
1.9 Specifications	6
1.10 Block Diagram	7
2.0 APPLICATION NOTES	8
2.1 Outdoor ILB Installation	8
2.2 Indoor Installation using Wireless and ILB	8
3.0 BASIC OPERATING INSTRUCTIONS	9
3.1 Sentinel Layout	9
4.0 WIRELESS SYSTEM AND SENSORS	10
4.1 Wireless Receiver and Sensor Range	10
4.2 DX Wireless Receiver and Sensor Programming	10
4.3 DX Wireless Receiver User Programming	10
4.4 Adding Transmitters	11
4.5 Reviewing Memory	11
4.6 Removing Transmitters	11
4.7 System Operation	11
5.0 WIRELESS TRANSMITTER SENSORS (DX) extended range	12
5.1 Passive Infrared DX: WLPIRDx	12
5.2 Exit/Entrance Delay Transmitter: WLEXITDX	13
5.3 Bait Money Sensor: WLBMDX	13
5.4 Door/Window Transmitter: WLDRDX	14
5.5 Pendant Transmitter: WLPTDX	16
5.6 Check Out, Test and Operation	17
6.0 INVISIBLE LIGHT BEAM (ILB)	17
6.1 Invisible Light Beam Check Out	17
6.2 Coverage Area	17
6.3 Alignment	18
6.4 ILB Test	18
6.5 Check Out and Operation	18
6.6 Invisible Light Beam Response Time	19
6.7 Range and Setback Adjustment	19
6.8 Light Beam Specifications	19
7.0 ACCESSORIES	19
8.0 SHIPPING INFORMATION	19

Due to differences in customers requirements there may be discrepancies between your Sentinel and this manual. If you have any questions regarding the operation of the Sentinel Portable Radio Alarms, please contact Karas Technical Customer Service at 831 685-0816 or e-mail customerservice@karastech.com

WARRANTY/DISCLAIMER

The products described in this manual are warranted to be free from defect in material and workmanship for a period of two years from the date of shipment. Within the two year warranty period we shall replace or repair such products which are returned to us with shipping charges prepaid and which are determined by us to be defective. This warranty does not apply to any product which has been subjected to misuse, negligence or accident; or misapplied; or modified; or improperly installed.

The foregoing provisions are our sole obligation and exclude all other warranties or remedies, expressed or implied, including warranties of merchantability and fitness for a particular purpose, whether or not purposes or specifications are described herein.

We further disclaim any responsibility whatever to the customer or to any person for injury to person, or damage to or loss of property or value during any use of our products. Under no circumstances shall the company be liable for any incidental, consequential or special damages or losses or expenses in connection with the use of, or inability of use of our product for any purpose whatsoever.

Warning: In installation and use of these products, comply with the National Electrical Code or any other applicable local safety codes. During installation, turn off power and take all other necessary precautions to prevent injury, property loss and equipment damage. Do not apply power until all wiring is completed.

Product Changes: We reserve the right to discontinue a particular product or make technical design changes at any time without notice.

1.0 GENERAL DESCRIPTION

The Sentinel 2200 series is a type of radio repeater. It receives digital alarm signals, associates them to voice messages and transmits them on voice radio frequencies using two-way Land Mobile Radio (LMR) conventional or trunked radio systems.

This complete user friendly signaling system is used for surveillance, security, emergency, industrial equipment monitoring or any other event that requires alarm or status monitoring. This unit comes with built-in electronic voice recorder/play back unit, remote wireless receiver, optional built-in interruptible invisible light beam sensor and four jacks for hardwired switch sensors, control and power connections. The electronic voice recorder can send up to four different voice messages; one for each of three zone inputs, plus one for unit identification with each transmission. Four additional messages are permanently recorded to indicate other conditions. Also available are optional tone signaling modes.

The Sentinel can be used in existing radio systems and monitored with your currently used radio equipment. The range of the Sentinel is comparable to a four watt handie talkie with a similar rubber duck antenna. The range can be extended with the use of an external antenna. Used in repeater systems, it has considerable range. It is completely self-contained for portable use and operates over a large temperature range so it may be left outdoors. It is easy to set-up and conceal. It contains a large 7 ampere hour rechargeable battery for long field use.

1.1 BASIC OPERATION DESCRIPTION

The 2200 series is a complete radio alarm system which incorporates a variety of sensing capabilities. This unit provides up to three zone sensing capability which allows three different user recorded messages to be sent, one for each zone. Zone one activates message number one; zone two, message two; and zone three, message three.

Each zone can be activated in a number of ways. First, zones one and two can be activated by a switch contact closure via each input jack on the outside of the 2200. This is for hardwire sensing devices such as switches, alarm relay panels, etc. Secondly, zones one, two, and three can also be activated by short range wireless sensors respectively, such as the bait money clip, passive infrared sensor or magnetic door switch. This allows for easy installation without the need for wiring. Zone three also has an alternate function. It is activated by the optional Invisible Light Beam (ILB) when installed and turned on. Whenever the beam is broken, message number three is transmitted. In addition to each zone message, a user recorded unit identity message, message 4, is sent after each alarm message sequence. This allows the user to identify which unit is operating should there be more than one in operation on a given radio frequency.

Additionally, four permanently recorded messages are used to indicate other functions. First is the unit alarm preamble. This message comes on first to identify that an alarm is being sent. The standard preamble message is "Sentinel Radio Alarm". Second, the unit Exit/Entrance Delay message which is "Exit/Entrance Delay" is transmitted when the Exit/Entrance delay is activated. Third, the "Ready" message is to indicate that the Sentinel has completed the Exit/Entrance Delay time and is ready for use. The Exit/Entrance Delay and the Ready message are only transmitted over the internal speaker. The fourth status message "Battery is low" is transmitted when the main battery voltage drops below a useable level or the sensor batteries are weak and need replacement. These messages can be customized at the factory if needed.

For each zone input activation, the 2200 sends the number of transmissions determined by the setting of the MESSAGE/REPEAT switch, at 20 second intervals. This allows for other radio transmissions to occur on the same radio frequency. For example, should the MESSAGE/REPEAT switch be set to three and zone one is activated, message one is transmitted followed immediately by the unit identity message. After a 20 second pause message one is sent again followed immediately by the unit identity message, again a 20 second pause and repeat of message sequence then the unit returns to READY. To reiterate, the message is repeated the number of times indicated by the MESSAGE/REPEAT switch with a 20 second pause between transmissions.

1.2 FAMILIARIZATION AND INITIAL CHECK OUT

Upon receipt of your Sentinel equipment inspect it for completion of order and any possible damage in shipment. When satisfied all items ordered are identified and appear to be in good condition you may proceed to initial familiarization and installation. With the case open and appearing as shown in figure 2, page 9, notice the location of the control switches and components.

The READY switch should be in the OFF position.

The ILB switch should be in the OFF position. (if equipped)

The MODE switch should be in PLAY.

The MESSAGE SWITCH should be in MESSAGE 1.

To test the unit for basic operation, put the ready switch all the way to ON/EXIT DELAY. This should turn on the active light. Press the RECORD/PLAY BUTTON, you should hear a message or a random noise if a message is not recorded. This verifies that the unit is working and ready to set up for operation.

For programming messages refer to section 3.0 page 9 or section 1.3 Operation and Recording Controls, Switches and Other Functions below for complete information.

WIRELESS CHECKOUT

Refer to WIRELESS check out section 5.6 page 17.

ILB CHECKOUT

Refer to ILB check out section 6.1 page 17.

1.3 OPERATION AND RECORDING CONTROLS, SWITCHES AND OTHER FUNCTIONS

ON/EXIT DELAY – READY – OFF/RESET SWITCH

This three position toggle switch is the primary operation switch. When this switch is in the OFF position the 2200 can not be activated. This position also serves as a reset function. When switched from OFF to the READY position the 2200 is ready to be activated but is still off. When any of the input functions are activated, i.e. hardwire switch, ILB or wireless receiver, the unit will turn itself on. The ON/EXIT DELAY position activates the unit manually for two purposes, first, when momentarily pushed to ON and the Mode switch is in Record or Play, it activates the unit to allow the user to record and verify messages. Second, EXIT DELAY, in conjunction with the MODE switch in TEST or OPERATE position, puts the unit in Exit/Entrance Delay mode, a condition which ignores sensor inputs for 60 seconds. This allows the user to leave or enter the premise without activating the unit prematurely. Note, the BUSY light blinks when the Sentinel is in Exit/Entrance Delay mode. Also the Exit/Entrance Delay mode can be activated by a wireless Exit/Entrance transmitter. The Exit/Entrance wireless activation uses the fourth channel of the wireless sensor receiver for activation.

MODE SWITCH

This four position slide switch has four functions. One, RECORD, in conjunction with the message switch and record/play push button switch, allows the user to record messages. Function two, PLAY, using the message and record/play switches, allows the user to verify messages recorded. The third function, TEST, allows the user to check out the system without transmitting over the radio. Messages are activated by sensor inputs and sequenced as in operate mode except alarm messages are directed to the speaker rather than to the radio transmitter. Function four, OPERATE, is selected when everything is ready for actual operation and alarm messages are transmitted over the radio.

MESSAGE / REPEAT SWITCH

This four position slide switch has two functions, the first, MESSAGE, is used to select one of four messages. Message one is for use with input jack one or the wireless receiver channel one. Message two is for use with input jack two, or wireless receiver channel 2. The third message is used by the ILB if included, as well as the third channel of the four channel wireless receiver. Message four is for the unit identity.

The second function, REPEAT, is the message repeat count. Depending on what number is selected, 1 through 4, the Sentinel will repeat the alarm message the number of times showing on the MESSAGE/REPEAT switch.

RECORD/PLAY BUTTON

This momentary push button switch is used to initiate the record function and is held down for the duration when recording messages. Also, it is used to initiate the playback verification.

USER RECORDED MESSAGES

When recording messages, speak in a normal tone of voice, about 1 to 2 feet away from microphone. You may try recording and playing back your messages a few times. Experiment with different inflection and articulation to achieve clear and understandable messages. The audio level that you hear from the prerecorded messages is the level you should hear when you play back user recorded messages. This will provide adequate modulation to the radio.

There are four variable length messages with a combined total time of sixteen seconds. A message must be recorded at each message number to keep message alignment correct during sequencing. If less than four messages are required, record a token message at the unneeded message number, i.e a momentary press of the record button to record a fraction of a second of silence. For example, the user may elect to record only two messages: a six second message for message 1, input 1 and a 2 second message for message 4, unit identity. Messages 2 and 3 could then be filled with token messages. If no message is recorded on message 2 or 3, they would use the message recorded on the previous recorded message number, i.e. message 1.

User Recorder Message	Function
1	Input Jack 1 or Wireless Receiver Channel 1 Zone 1
2	Input Jack 2 or Wireless Receiver Channel 2 Zone 2
3	ILB or Wireless Receiver Channel 3 Zone 3
4	Unit Identity

Message Select Function Table

PERMANENT VOICE MESSAGES

There are four permanently recorded voice messages in the Sentinel. First the alarm preamble "Sentinel radio alarm" which is standard or custom messages such as siren or beeps. Second a "Battery is low" message is sent when battery is too low for reliable operation or the sensors batteries are weak. Third, "Exit/Entrance Delay" message is sent over the speaker every time the Exit/Entrance Delay is activated. Four, the "Ready" message is sent over the speaker when the unit finishes the Exit Delay sequence and is armed and ready. These messages can be customized at the factory by request.

MICROPHONE

The microphone is built-in and is located in the upper right center of the panel. Audio record levels are preset. Audio levels are adjusted by how loudly the messages are recorded.

SPEAKER

The speaker is set for a nominal output that would be equivalent to a person speaking in a normal voice. If the user needs more or less volume, there is a small trim control (VOL) on the main circuit board near the speaker for this adjustment.

1.4 INDICATORS

BUSY/EXIT DELAY LIGHT

This light is lit when recording or verifying a recorded message during play back and during a message transmission in either test or operate. Also, this light blinks at a rate of 5 flash-

es per second when the unit is in the Exit/Entrance Delay mode. When the light stops blinking the unit is ready to be activated.

ACTIVE LIGHT

The Active Light indicates that the Sentinel is powered and in operation. When current message sequence is complete it will turn off. Also, this light will be turned off if the READY switch is off.

LOW BATTERY LIGHT

This light turns on when the battery voltage drops below the recommended operating voltage of approximately 10.5 volts. It will turn off when the battery is recharged to approximately 80% charge or about 13.5 volts. Also, when this light is on, and the READY switch is in Ready, the Sentinel will send battery low message.

TO RESET BATTERY LOW LIGHT (Turn Off)

If you need to operate the unit without a full charge, such as when testing or changing the battery in the field, put the Ready/Off switch in the Reset/Off position. This resets the low battery detector. The Low Battery Light won't come on again until the battery discharges to about 10.5 volts. If the light stays on, the battery is below 10.5 volts and should be recharged.

BATTERY CHARGER/A.C. POWER ON LIGHT

This LED is on whenever the unit is plugged into an A.C. power outlet or is receiving alternate D.C. input (ALTDCIN). It also indicates that the battery is being charged if the battery is connected.

BATTERY FUSE LIGHT

If the battery fuse LED turns on (either green or red) the battery fuse is blown. The light will be green when the Sentinel is trying to charge the battery, i.e plugged into an A.C. power outlet. The light will be red when the battery is trying to power up the Sentinel. Under certain conditions the light may not turn on, such as having a fully charged battery and the A.C. power cord plugged into a power outlet and the READY switch in the off position. You can test for this condition by disconnecting the A.C. power cord from the power outlet and putting the READY switch in the on position. If the fuse is blown, the battery fuse light will turn on. To turn off the light replace the fuse. If it blows again, send the unit to the factory for repair.

A.C. OVERLOAD LIGHT

The A.C. Overload Light comes on if there is a power supply problem that is drawing too much current from the A.C. power line. If this light comes on, disconnect the A.C. power for about five minutes. When plugged back in the light should stay off . If it comes on again, most likely there is a power supply problem and the unit should be returned to the factory for repair.

1.5 INPUT/OUTPUT JACKS-Master or Slave operation

These inputs are used to control the Sentinel alarm transmissions.

INPUT 1, INPUT 2 (Slave operation)

Closing the circuit, between the input jack center conductor and the outer barrel mounting case of the jack, activates the 2200. Time required from input switch closure to activation is approximately 10 milliseconds. Accessories such as the wireless receiver are also connected to these inputs in parallel with the input jacks. Input jack 1 activates message 1, and input jack 2 activates message 2. The plug used for hardwire sensor inputs is a Switchcraft model number 142A or similar 3.5mm mono plug.

ALTDCIN

This is an alternate function for input 2. When properly configured, it is the input jack for alternate D.C. voltage sources such as a solar panel. When set to be used as power input, it no longer works as a sensor input.

ENABLE

The enable input is used to disable the Sentinel alarm when it is closed, shorted. This input is used with external control devices such as the Scheduler or external access key pad.

RELAY OUTPUT (Master operation)

The Sentinel comes with a relay contact output connection. When the Sentinel is in test or operate modes and is triggered by an alarm, the relay contact closes for the duration of the alarm condition. When the alarm messages are complete and the Sentinel goes inactive, the relay opens.

This function is useful when using the Sentinel Alarm to be the master controlling other electrical equipment such as a VCR, camera or phone dialer.

1.6 POWER SUPPLY

The Sentinel power supply is designed to provide reliable operation. It is comprised of an A.C. to D.C. power supply to rectify and regulate A.C. line power to supply the Sentinel circuitry, radio circuitry, and battery charger. A thermistor is placed in series with the A.C. power line to the power transformer for protection. When there is an A.C. power overload, the thermistor reduces power to the transformer and the A.C. overload light comes on. To turn off the A.C. overload light, unplug the unit for a few minutes so the thermistor can cool. Re-plug in the A.C. power cord and wait a few minutes. If the A.C. overload light comes on again, there is a power supply problem. Send the unit to the factory for repair. For some radio options the power supply will not operate the unit properly without the battery connected.

BATTERY

The battery supplied with this unit is a lead acid gel cell battery which can operate in any position. The battery charging circuitry in the 2200 is voltage and current limited, temperature compensated and designed to give the best performance for the batteries supplied, (NP7-12). It is best to recharge the battery at room temperature. It should take approximately 24 hours to recharge the battery to a usable level once the battery light has come on. When battery is approximately 80% charged, battery low light will go off. The battery supplies the memory back-up power for the voice recorder memory. Disconnecting the battery for more than 30 seconds may corrupt the messages recorded in the voice memory. When not in use, it is a good idea to keep the unit plugged in to A.C. power to keep the battery in top condition and charge. To insure against loss of voice memory when changing battery, have Sentinel plugged into A.C. power during battery change. The memory has a keep alive capacitor that will hold the memory for about a minute in case the power and battery are disconnected at the same time. The Battery is fused with a 4 amp fast fuse.

POWER MANAGEMENT

When operating only off the battery the 2200 is designed to use very little power. When in the READY mode, i.e. waiting for a contact closure from one of the inputs to activate the unit, only the input sense circuit, voice memory and battery low detection circuitry are powered. When the READY switch is off, the typical current is less than one milliampere which should hold voice memory for over 200 days. When in the READY position, the model 2200 will operate for a week or two, depending on battery conditions. When the Invisible Light Beam is on, the unit will operate approximately 4 days to a week depending on battery charge. Operating length time in the field depends on conditions such as temperature, battery age and condition. When the battery is discharged to a marginal operating level the battery light will come on and will send the battery low message, if the READY switch is in the READY position. This eliminates the guess work as to how long you should leave the unit in the field.

A.C. POWER CORD STORAGE

The A.C. power cord is permanently attached to the Sentinel control panel and is stowed in the cover section of the case. It is attached to the cover with two cable clips attached to the cover sides. When stowing the power cord, route it in a clock-wise direction. It should make one and three-quarters loops around the cover with the power plug ending up in the lower right corner of the cover. When using the power cord with the case closed, the cord should be routed through the cord recess at the left side of the control panel.

1.7 RADIO, CONNECTIONS AND ANTENNA

Each Sentinel unit is equipped with a hand held type radio transmitter that is user specific, depending on the system to which it is to be interfaced. Each radio has the same basic wiring requirements regardless of its operating frequency. Two or three cables are used for these connections. One cable is for the transmitter power. The second cable has the modulation and control interfacing. The third is the RF output and is usually connected to a rubber duck antenna. This connector also is used to route radio frequency power from the transmitter module to outside the Sentinel case to an external antenna via a coaxial cable, 50 ohms. The user only needs to access these cable connections when removing the two-way radio from the Sentinel case.

RADIO MODULATION CONTROL

The radio modulation is set at approximately 4-6Khz deviation (wide) normally, narrow, 2-3Khz deviation on request. It varies depending on how loudly the user records their messages. A modulation control is provided on the main circuit board near the radio control cable (speaker mic cable), marked (MOD).

1.8 PANEL ACCESS

The panel of the Sentinel may be removed for access to the interior of the unit. Open case and position it so the panel is facing up and the case handle is toward you. Before removing front panel, disconnect battery and unplug A.C. power cord. Remove the four 10-32 screws with nylon washers. Lift the edge of the panel closest to the case handle to clear the ILB module (if installed). Lift the panel up and put it in a vertical position and lean the panel against the case cover. This should expose all the internal components. When installing panel, set rear left corner of control panel on mounting bracket first and then the right side of the panel on the right rear mounting bracket. Now lower front end of control panel into case and set firmly against front mounting brackets. Insert retaining screws and tighten.

1.9 SPECIFICATIONS

User recorded messages:	4 maximum, variable in length, 16 seconds total time
Permanent messages:	4, preamble, exit/entrance delay, ready, battery low
Radio transmitter:	1 to 5 watts Icom, other or user supplied FCC approved
Frequencies:	VHF, UHF, land mobile, 800/900 trunked and conventional
Inputs:	Two input jacks for external hardwired sensors, or other control device. Normally Open, Active = Closed WLRX, 4 channel wireless receiver, internal ILB, active Infrared (optional) Enable, close contacts to disable unit ALTDCIN, This Optional input is used for external D.C. voltage input, 17-24 VDC, i.e. Solar panel Input jack is rated at 1 Amp maximum
Outputs:	One antenna jack, for portable rubber duck type (BNC connector optional) for other antennas/cables Relay contact, 1 Form C, normally open
Controls:	Ready toggle switch, panel mounted ILB toggle switch, panel mounted Mode switch; record, play, test, operate Message/Repeat switch; 1-4 positions Play/Record push button
Carrying case:	Metal frame and plastic shell, Zero manufacturing

Dimensions: 5" Deep x 12" Wide x 9" High.

Power requirements: 115 VAC \pm 10%, 20 watts during transmit, 300 milliwatts in READY mode, built-in power supply/battery charger and internal rechargeable 12.6 volt 7 Ahr sealed battery (NP7-12) The Battery is fused with a 4 amp fast fuse.

Wireless sensor system: Linear Corp. DX series

Environmental: Temperature range; -30° to 60° C, -22° to 140° F

1.10 BLOCK DIAGRAM

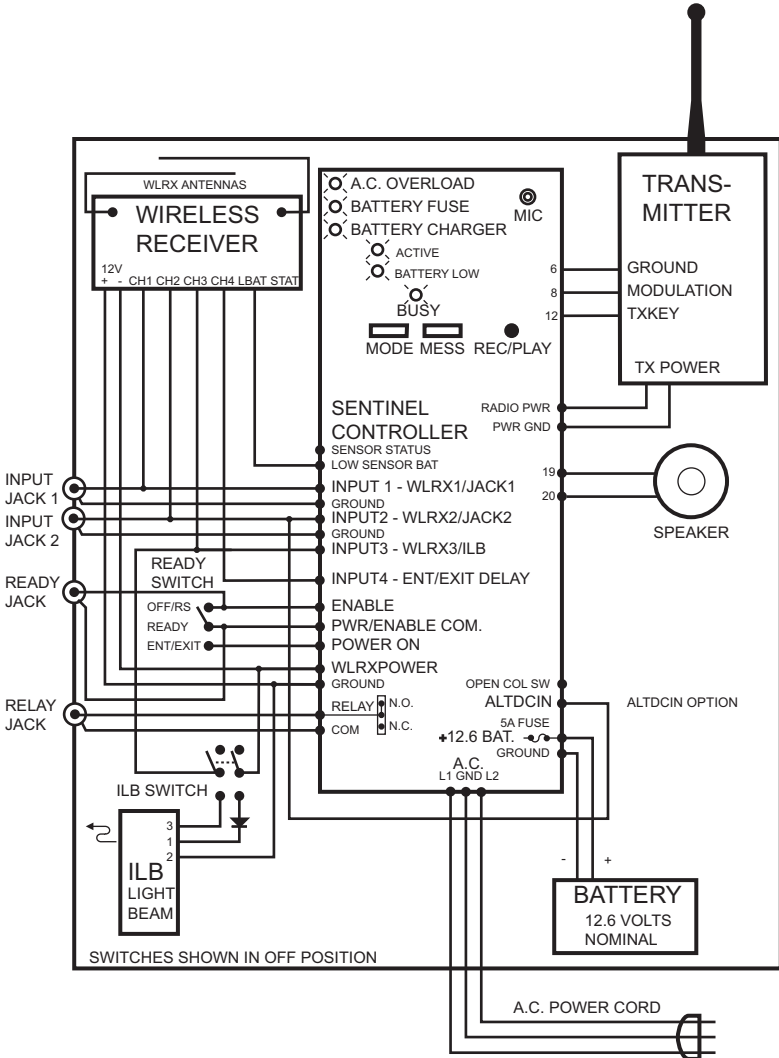

2.0 APPLICATION NOTES

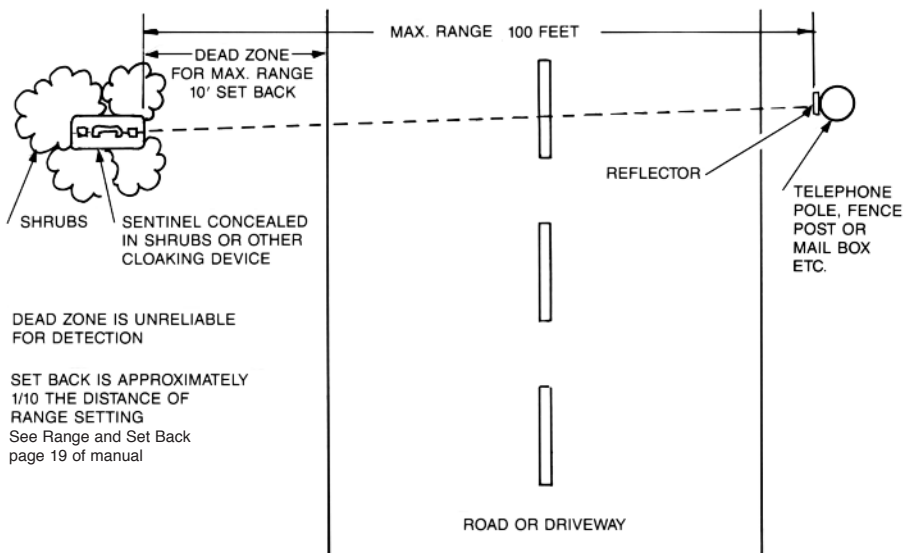

2.1 OUTDOOR ILB INSTALLATION

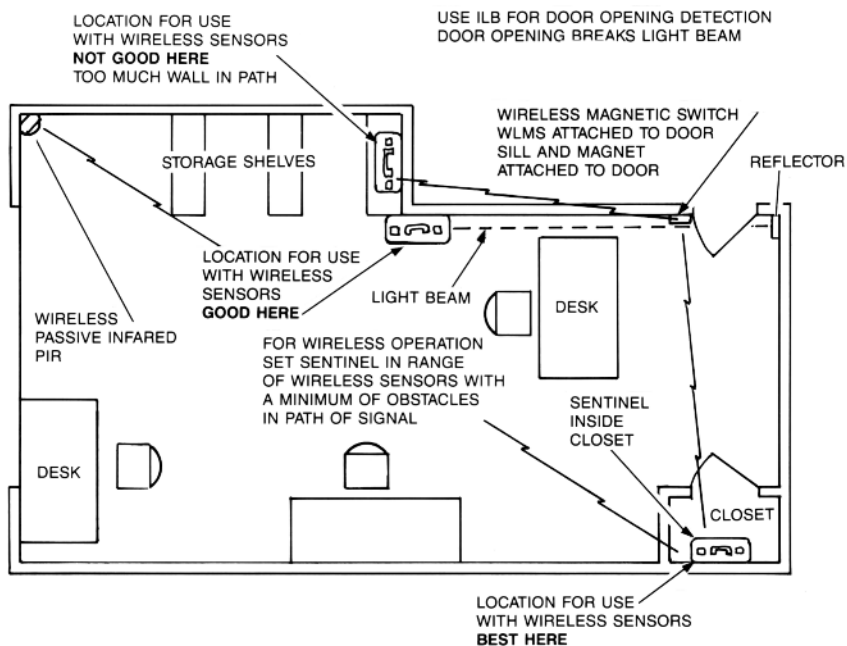

2.2 INDOOR INSTALLATION USING WIRELESS AND ILB

3.0 BASIC RECORD/PLAY INSTRUCTIONS

For functions and panel layout refer to figure 2.

1. RECORD AND PLAY

Initialize Sentinel by putting READY switch in RESET and put MODE switch in RECORD. Now move READY switch all the way to ON. This turns on the Sentinel.

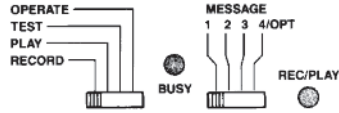

2. To record MESSAGE 1 (alarm zone 1, input jack 1) put MESSAGE switch at message 1. Now press the REC/PLAY button. When the BUSY light comes on, speak towards the MIC from a distance of one to two feet. Let up on the REC/PLAY button as soon as your message is complete. If the BUSY light goes out before you complete your message, you have run out of recording time, try shorter messages.

3. Verify your message by putting the MODE switch in PLAY and pressing the REC/PLAY button momentarily. You should hear your voice message from the speaker.

4. To record MESSAGE 2 (alarm zone 2, input jack 2); MESSAGE 3 (alarm zone 3, ILB option); and MESSAGE 4, Unit identity; put MESSAGE switch in appropriate position and repeat steps 2 and 3. This completes the voice message programming. For additional information refer to manual section 1.3 page 2 operation and recording controls, switches and other functions section.

3.1 SENTINEL LAYOUT

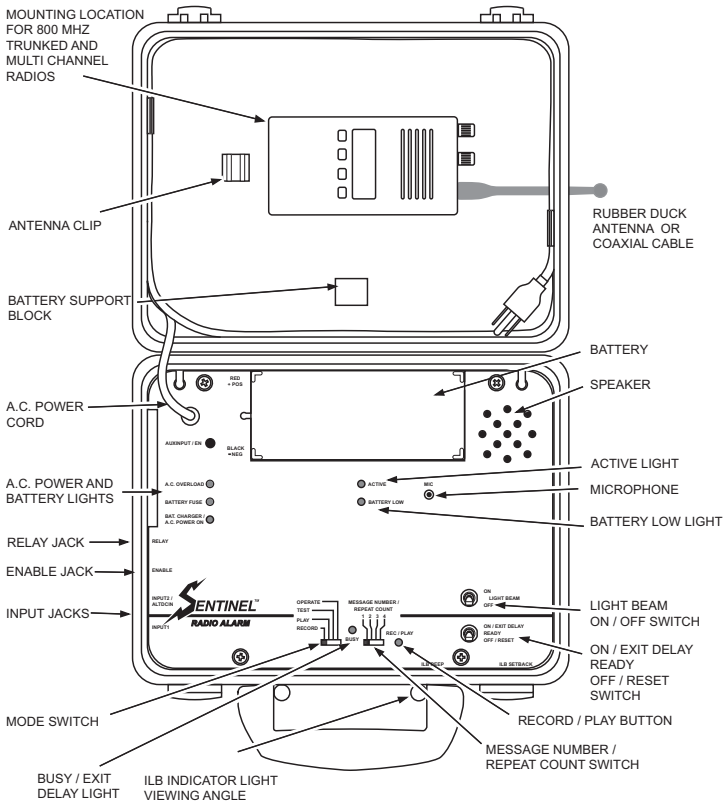

Figure 2: 2200 showing panel layout and general radio location

4.0 WIRELESS SYSTEM AND SENSORS

The Sentinel 2200 series is designed to work with extended range (DX) external wireless transmitter sensors and built-in 4 channel (DX) receiver. The Sentinel short range wireless receiver/transmitters operate similarly to those found in many security alarms. It operates on the UHF radio band and uses short bursts of data transmitted to receivers with the sensor address code. Each sensor has its own unique address code. Initiating a transmission is accomplished by closing wireless sensor switch contacts like the door/window sensor, pushing panic button, or pulling cash from cash clip, etc. When the short range wireless receiver receives a signal with a programmed sensor code, it activates the Sentinel to send its appropriate voice message over your radio system.

4.1 WIRELESS RECEIVER AND SENSOR RANGE

Each wireless receiver incorporates a dual high-sensitivity superheterodyne diversity receiver with two antennas. This type of receiver provides superior performance by preventing loss of signal due to multi-path interference. An automatic level control circuit adjusts the receiver's sensitivity depending on conditions. For versatility any transmitter can be programmed into any receiver channel. Receivers must be programmed to recognize the transmitters code before system testing and operation. Up to 32 transmitters can be programmed into the receiver. This unit fits entirely inside the Sentinel carrying case and operates from the main battery (approx. 25 milliampers) when activated (Ready). Depending on operating environment, the ranges of wireless DX transmitters vary from approximately 100 feet to more than 500 feet from the DX receiver depending on conditions.

4.2 DX WIRELESS RECEIVER AND SENSOR PROGRAMMING

The DX sensors require no address setting. The digital DX code format features over a million possible codes. The DX sensors transmitters are precoded at the sensor factory to unique codes. All DX transmitters used in Sentinel radio alarms are alarm codes, except for the Entrance/Exit delay transmitter.

Each wireless sensor is programmed into the Sentinel wireless receiver at the Karas Technical Services factory. However the user may want to add sensors or move them from or to another system. If you should want to use a sensor with more than one Sentinel radio alarm system, it must be programmed into the other Sentinel wireless receivers. Each sensor is received only by the receiver(s) to which it was programmed. To do so refer to DX wireless receiver instructions for programming below. If end user is not inclined to program the receiver themselves, Karas Technical Services will do it for a nominal fee.

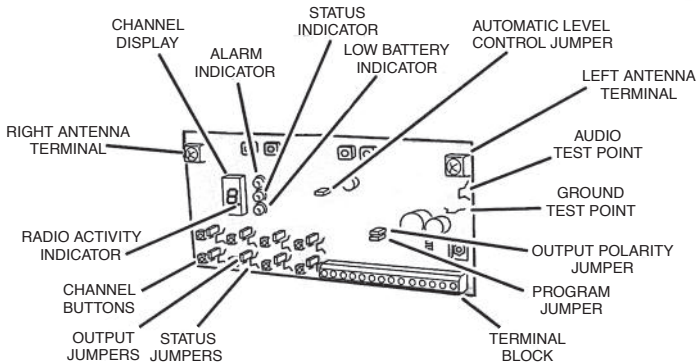

Figure 3: Receiver Component Locations

4.3 DX WIRELESS RECEIVER USER PROGRAMMING

To access the wireless receiver, the Sentinel panel has to be removed. See section 1.8, page 6 for panel removal instructions. Once the panel is removed and the wireless receiver is visible, programming may begin. First, put mode switch in play position, Second, activate the Sentinel by putting the Ready switch in the ON position, and release to the Ready position. This turns the Sentinel on. Now the wireless receiver is ready for programming.

The following numbered steps and illustrations show how receiver programming is accomplished.

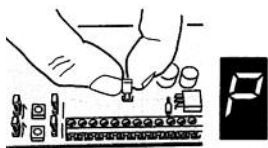

Figure 4

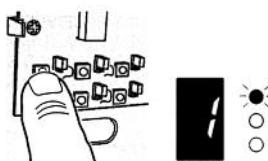

Figure 5



Figure 6

4.4 ADDING TRANSMITTERS

1. Remove the program jumper. The channel shows P. See Figure 4.
2. Briefly press the button for the channel that the transmitter is going to be added into, the channel number shows on the display. See Figure 5.
3. You have 5 seconds to activate the transmitter the alarm LED will Blink. See Figure 6
4. After the Transmitter is entered, or after 5 seconds, the channel display will return to "P"

Repeat steps 2 & 3 for additional transmitters (Up to 32 total with any mix of channels) then replace program jumper when finished

Note: On multi-button transmitters. Each button has a unique code and is added to the receiver separately, into any channel.



4.5 REVIEWING MEMORY

1. Remove the program jumper. The channel shows P. See Figure 4.
2. Press and hold the button for the channel to review until the alarm LED starts to blink then release the channel button. See Figure 5.
3. Count the number of times the alarm LED blinks, this is the number of transmitters programmed into the channel.

Repeat steps 2 & 3 to review other channels

Replace the program jumper when finished



4.6 REMOVING TRANSMITTERS

1. Remove the program jumper. The channel shows P. See Figure 4.
2. Press and hold the channel button for the channel to erase. Continue holding down the button while the alarm LED counts the number of transmitters Keep holding the button down. See Figure 5.
3. The display will continue to show the channel number. Keep holding down the channel button until the alarm LED flashes twice, signaling the channel has been erased

Repeat steps 2 & 3 to erase other channels

Replace the program jumper when finished.



4.7 SYSTEM OPERATION



The center bar of the channel display will blink while the receiver is idle

The decimal point will light when any incoming radio signals are present



When any channels are in alarm, or have any supervisory conditions, the channel number(s) will show on the channel display, advancing in ascending order

As each channel number is displayed, its condition is shown on the three indicators (Alarm, Status, or Low Battery)



When all outputs are restored (Non-Alarm condition), either by restore transmissions or by manually resetting latched channels with the channel buttons, the channel display will return to the blinking bar.

5.0 WIRELESS TRANSMITTER SENSORS (DX) extended range

Each DX sensor supplied with a Sentinel Radio Alarm is preprogrammed with one of over a million unique codes. No field programming of transmit sensors is required. For versatility, any transmitter can be programmed into any sensor receiver channel. The Sentinel DX sensor receiver is preprogrammed at the factory for each sensor shipped with it. The sensor receiver in the Sentinel may be reprogrammed by user should the need arise. See section 4.2, page 10.

5.1 PASSIVE Infrared DX: WLPIRDx

The WLPIRDx is a battery powered passive Infrared motion detector with built in wireless transmitter. This transmitter can be used in a variety of motion detection applications. When the passive Infrared sensor detects motion in its field of view the transmitter sends a digitally coded wireless message to it's companion receiver.

GENERAL SPECIFICATIONS: WLPIRDx
Wireless Passive Infrared motion detector

Battery: one 9 volt alkaline battery

Battery life: three years typical

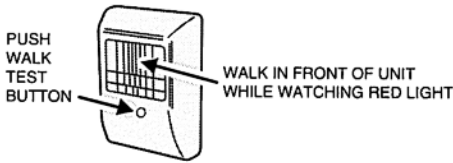
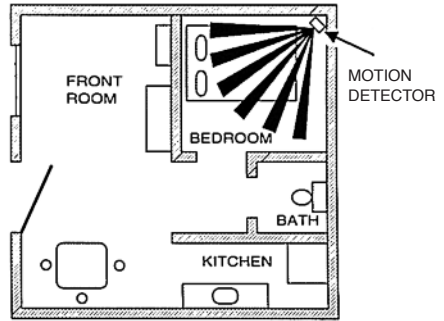

UNIT WILL STAY IN WALK TEST MODE FOR 4 MINUTES AFTER PRESSING WALK TEST BUTTON

VERIFY THAT DETECTION PATTERN COVERS DESIRED AREA

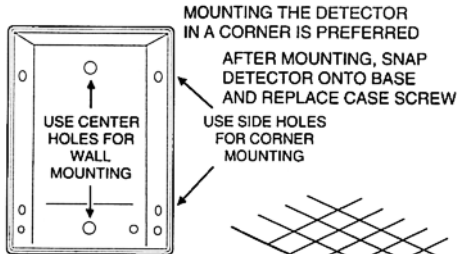
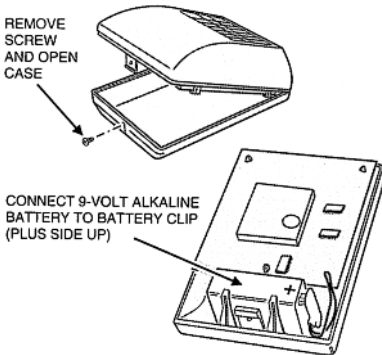
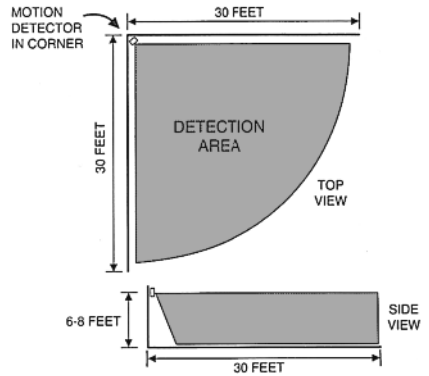
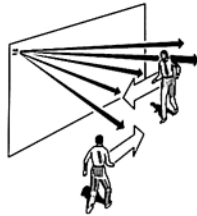

PUNCH OUT REQUIRED HOLES FOR SCREW MOUNTING

NOTE:
THE DETECTOR CAN BE MOUNTED WITH DOUBLE STICK TAPE, BUT SCREW MOUNTING IS PREFERRED

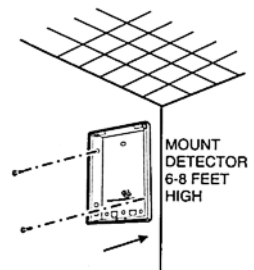

Measured range: 500 feet in open air

5.2 EXIT/ENTRANCE DELAY TRANSMITTER: WLEXITDX

The Exit/Entrance Delay wireless switch is a single channel manual push button DX wireless transmitter. Like the other wireless sensors it has its own internal code. The difference is the Exit/Entrance Delay device transmits on channel 4 only. Be sure that the Exit/Entrance Delay transmitter is on the correct channel, it is set for the channel at the factory and should

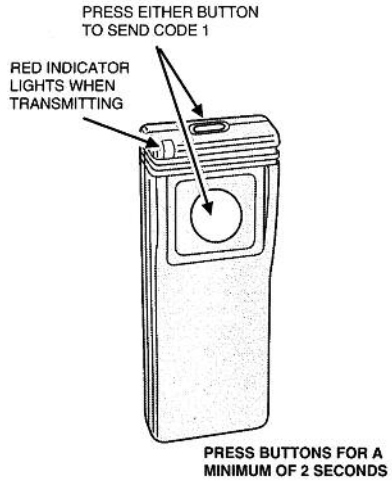
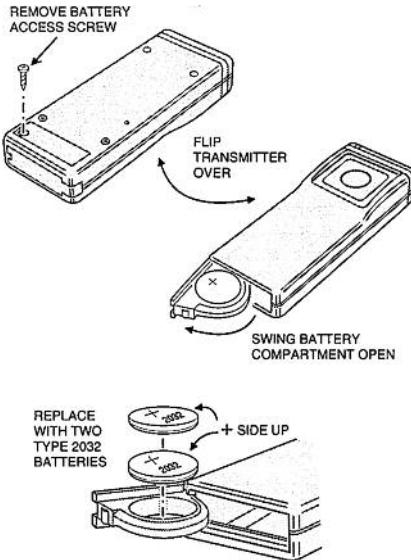

not need to be changed.

GENERAL SPECIFICATIONS: WLEXITDX
Wireless Exit/Entrance Delay transmitter

Battery: two 3 volt DL-2032 lithium batteries

Battery life: five years typical

Measured range: 500 feet in open air

5.3 BAIT MONEY SENSOR: WLBMDX

The WLBMDX is a battery powered cash drawer bill trap with built in wireless transmitter. This transmitter can be used in a variety of retail hold-up applications.

The WLBMDX is concealed in a cash drawer under a stack of currency with a single "bait" bill secured in its money clip. During hold-up, the cashier removes the stack of currency along with the "bait" bill. When a "bait" bill is removed, the transmitter sends a 1 second digitally coded wireless signal to its companion receiver. Four additional 1 second signals are sent within the first minute after the "bait" bill is removed.

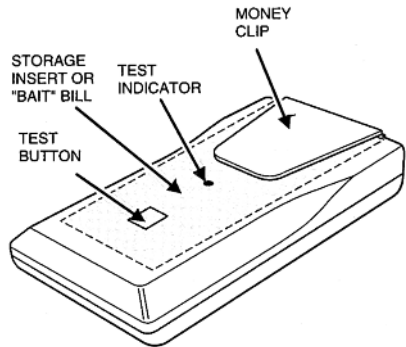

GENERAL SPECIFICATIONS: WLBMDX

Wireless Bait Money transmitter

Battery: two 3 volt DL-2032 lithium batteries

Battery life: three years typical

Measured range: 500 feet in open air

STICK VELCRO TO BACK OF UNIT
(DON'T COVER BATTERY DOOR)

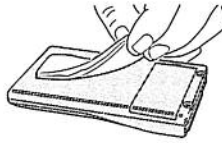

REMOVE STORAGE INSERT
AND SLIDE BAIT BILL
UNDER MONEY CLIP

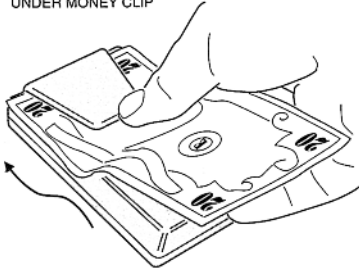

PULL BAIT BILL FROM
MONEY CLIP

VERIFY THAT RECEIVER
ACTIVATES WHEN
BILL IS PULLED

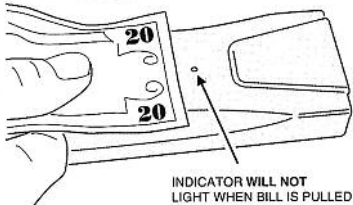

PEEL OFF BACKING

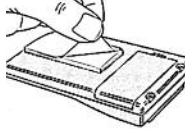

STICK TRANSMITTER INTO
CASH DRAWER TRAY

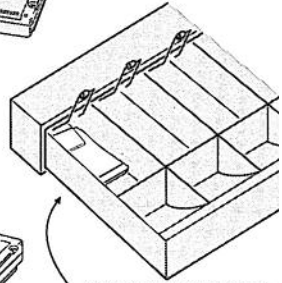

WHEN BATTERIES GET LOW
TEST INDICATOR WILL
BLINK WHEN TEST BUTTON
IS PRESSED

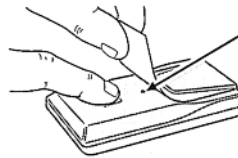

TRANSMITTER MOTION
SENSOR DETECTS WHEN
DRAWER IS OPEN

AUTOMATIC LOW BATTERY
TRANSMISSIONS WILL OCCUR

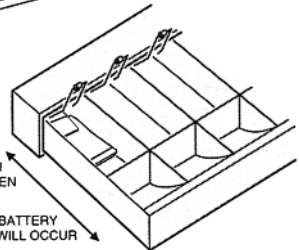

5.4 UNIVERSAL DOOR/WINDOW TRANSMITTER: WLDWDX

The WLDWDX is a battery powered stationary wireless transmitter designed to use in a limitless number of wireless remote control applications. Triggering the transmitter with its built-in magnetic switch, an external switch or an external glass break sensor sends a digitally coded signal to the wireless receiver inside the Sentinel case.

In a typical installation, the magnet is mounted on a door or window and the transmitter is mounted on the frame.

When the magnet moves more than approximately 1/2" away from the transmitter, an alarm signal is sent. Alarms can also be sent from external contacts wired to the terminal block. Pressing the case sends a test transmission.

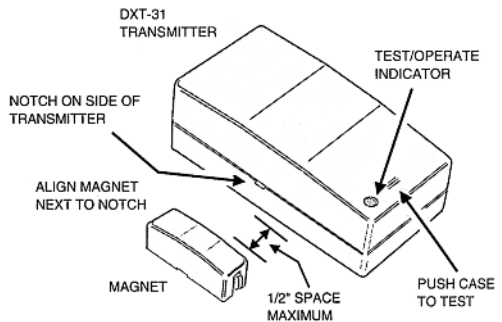

The transmitter is powered by two lithium batteries. The red test/operate indicator lights during operation and test. It will blink during operation and test when the batteries are low. A three position terminal block is for connection to normally open external contacts or a normally open window bug type glass break sensor. An internal jumper selects which input to use.

This Wireless Transmitter is used with other wired sensors to make Sentinel sensors, such as the mat, tilt, vibration and window break sensors. The internal terminal block is used to wire these other sensors.

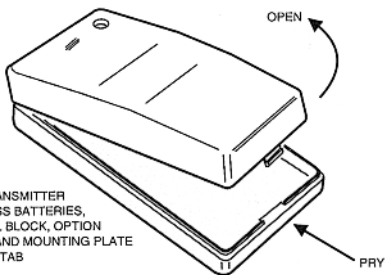

OPEN TRANSMITTER TO ACCESS BATTERIES, TERMINAL BLOCK, OPTION JUMPER AND MOUNTING PLATE RELEASE TAB

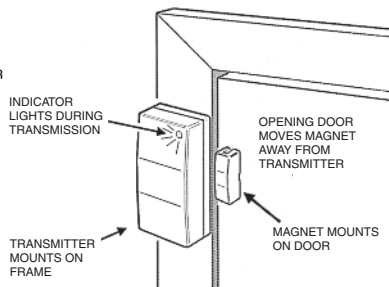
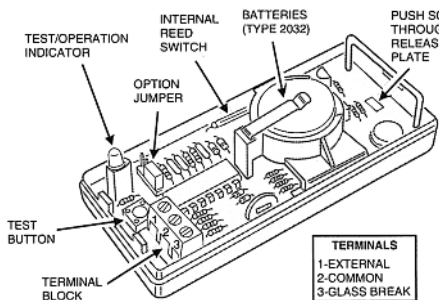

The magnet has four height positions.

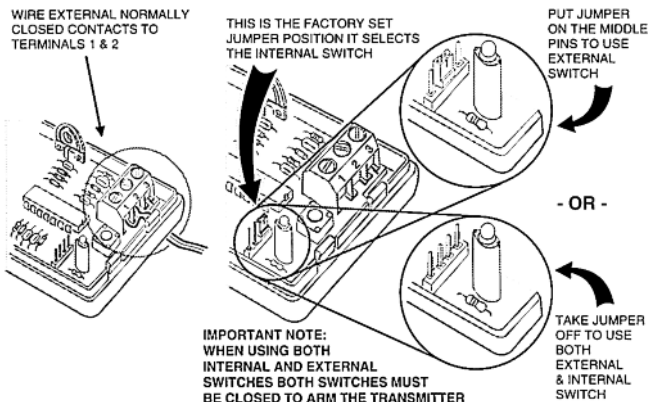
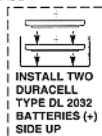
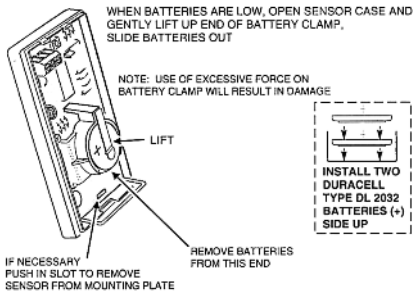
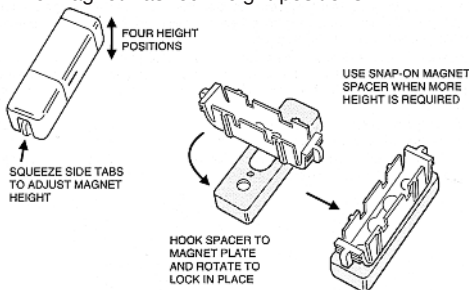

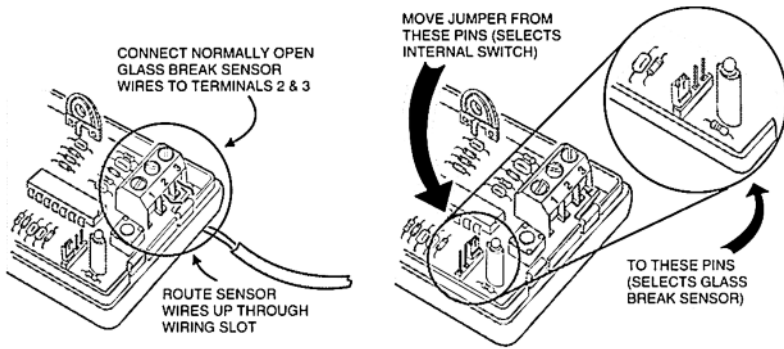

SPECIFICATIONS: WLDWDX

Wireless Door/Window transmitter

Battery: two 3 volt DL-2032 lithium batteries

Battery life: three years typical

Measured range: 500 feet in open air

5.5 PENDANT TRANSMITTER: WLPTDX

The WLPTDX is a battery powered portable miniature transmitter designed for use with Sentinel wireless radio alarms. The transmitter can be used in a limitless number of wireless remote control applications. Pressing the button on the transmitter sends a digitally coded wireless signal to its companion receiver. Pressing the button for two seconds insures receiver activation.

The WLPTDX transmitter is powered from a 12 volt battery with an expected battery life of about one year. When the transmitter does not function, or its range decreases, replace the battery.

GENERAL SPECIFICATIONS: WLPTDX

Wireless Pendant transmitter

Battery: one GP-23 12 volt alkaline battery

Battery life: one year typical

Measured range: 250 feet in open air

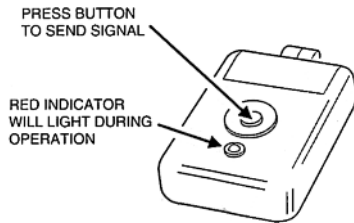
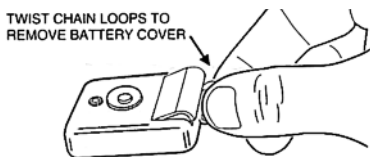

PRESS BUTTON FOR A MINIMUM OF 2 SECONDS

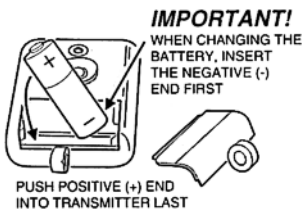

5.6 WIRELESS CHECK OUT, TEST AND OPERATION

In this example check out, we will use any one of the wireless sensors which has a manual test button such as wireless door/window WLDRDX. We will use the test button to activate the system.

WIRELESS SENSOR BATTERY CHECK

If installed, turn off ILB, to avoid accidental activation by that device. Put READY switch in the OFF position for now. First, check battery in wireless transmitter to insure that it is connected and in good condition i.e. fresh. Now activate the wireless sensor you wish to test. Each wireless sensor has some form of test or manual operation capability. Refer to specific sensor information for location or method of manual activation for testing. The red indicator light should come on where applicable. This indicates the battery is good and the transmitter is sending a signal. If not, the battery is probably weak. Change and proceed.

WIRELESS SENSOR CHECK

After you confirm that the transmitter sensor is working, put the MODE switch in TEST. This will direct voice alarm messages to the speaker. Switch the READY switch to READY. Now activate any of the wireless sensors that you are testing. Test only one sensor at a time. The active light on the 2200 should come on and you should hear message one on the speaker. Operate the wireless sensor transmitter from the location of the area to be protected. This will help locate possible null areas where structural materials and/or certain appliances may interfere with transmission. Relocate sensor if intermittent operation occurs and try again. Repeat this test for all sensors you wish to use. This is all that is required to check out the wireless sensors and receiver. To terminate active condition of 2200 return READY switch to OFF position.

ON THE AIR RADIO CHECK

Finally, try the sensor on your radio frequency. Put the MODE switch in OPERATE, put READY switch in RESET momentarily and return to READY. Activate any wireless sensor and you should hear the wireless message on your radio channel.

CAUSES FOR NON-OPERATION

Note that some wireless sensors have a retransmit delay time and the WLPIRDY requires up to five minutes of quiet time before reactivation. It is also possible that other electronic equipment operating near the Sentinel can interfere with the Sentinel short range wireless receiver. It is advisable to keep the Sentinel away from other electronic equipment, such as computers, when in operation.

6.0 INVISIBLE LIGHT BEAM - ILB (optional)

The ILB is an invisible infrared light beam emitter/receiver and operates in what is called the reflective or retro mode. The emitter and receiver are at the same location and the light beam is reflected off a passive reflector up to 100 feet away. It will sense when any object comes between the reflector and the light emitter/receiver and interrupts the light beam. When the light beam is broken it will activate the Sentinel. An indicator light is provided to show whether or not the light beam is being reflected back to the ILB and is used for alignment

6.1 INVISIBLE LIGHT BEAM (ILB) CHECK OUT

The ILB sensor indicator light is located inside the Sentinel carrying case. See page 18, figure 7. This light can be viewed through the peep hole at the angle indicated in figure 8. To get a feel for its operation, turn the ILB switch ON, put your hand over the ILB aperture and look through the peep hole at an angle towards the ILB aperture. You should be able to see the red ILB indicator light. Point the Sentinel ILB aperture in a direction in which there are no walls or other reflective surfaces within ten feet of the Sentinel. Remove your hand from in front of the ILB aperture. You should see the ILB indicator light go out. When you have become familiar with where to look for the ILB light you can set up the Sentinel ILB sensor.

6.2 COVERAGE AREA

When preparing to install for operation, choose the line of sight carefully for the ILB and reflector. An important part in operation is finding proper placement for the device to give the

most reliable results. Generally the user has the best idea of how and where to place the ILB for its particular application. When choosing this imaginary line for the trip zone, be sure no objects will interfere with the light beam accidentally. Place the Sentinel unit at one end and the reflector at the other. Attach the reflector to a wall or other surface to which it can be mounted. Use double sided foam tape, tack, nail, screw or whatever is appropriate for the installation. Be sure to maintain the required setback distance as per sensitivity setting, see range and setback section.

6.3 ALIGNMENT

Before setting up the ILB, be sure that the READY switch is in the OFF position. Flip the ILB switch to ON. The ILB is mounted internally and its light beam is aligned parallel to the edge of the carrying case where the latches are. Open the 2200 Sentinel case and position as shown in figure 8 with the ILB aperture pointing towards the reflector. Looking along this edge of the case at the reflector will sight in the ILB. A PEEP HOLE located under the case handle will allow you to look inside the 2200. The ILB indicator light is mounted at an angle to the peep hole such that you can see it readily from the sighting position. Look through peep hole for ILB indicator light. You may have to aim the Sentinel a little right, left, up or down to get maximum strength of reflected light. Stronger reflections are indicated by a faster flicker rate of Indicator light. A steady light indicates maximum reflection. If moving the Sentinel up or down is difficult you may reposition the reflector to suit the position of the Sentinel.

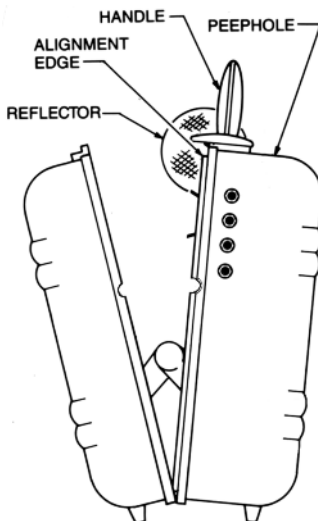

Figure 7: 2200 alignment position

6.4 ILB TEST

Once Sentinel is sighted and ready for operation, flip READY switch to READY and put MODE switch in TEST. This allows the Sentinel to be activated when the light beam is broken. Verify this by interrupting the light beam and listening to the Sentinel 2200 speaker for the ILB messages.

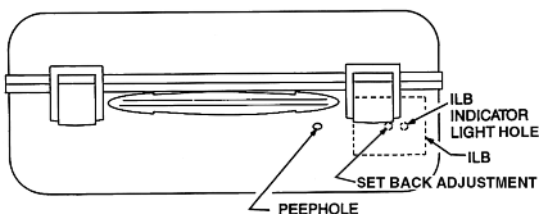

Figure 8: 2200 viewed from above

6.5 CHECK OUT AND OPERATION

When all sub-systems are checked out and operational, check the unit on the operating radio channel. Monitor your radio receiver for any activity. Be sure you're not interfering with radio channel usage. Put MODE switch in OPERATE and the READY switch in READY, turn ILB ON and break the light beam. After a few seconds you should hear the appropriate message on your radio.

6.6 ILB RESPONSE TIME

The ILB is designed to detect relatively slow moving objects, i.e. an object one foot across going no faster than 34 miles per hour. This is effective for people, vehicles and medium to large animals. Generally, set up the path of the beam where a relatively wide area of the objects to be detected will interrupt the light beam. This should insure detection at higher speeds.

6.7 RANGE AND SETBACK ADJUSTMENT

The setback is the area immediately in front of the ILB sensor where the light is so strong that it will reflect off just about anything, such as the object to be detected. To eliminate this from occurring, you must set the ILB back from the area to be observed. For maximum range the setback distance is about 10 feet, for short setback requirements, you must reduce the ILB sensitivity, thus reducing the range. This is done by adjusting the sensitivity screw on the ILB through the setback adjustment hole with a small screwdriver, see Figure 8. Turn this screw counter clockwise for less sensitivity and less setback. Note that this adjustment maintains a range to set back ratio of approximately ten to one, i.e. if the setback is three feet then the range is about 30 feet. The best way to check for set back is to adjust range/setback screw for maximum range. Have someone stand in front of the ILB at the set back distance desired so that the indicator light comes on. Then turn the range/setback adjustment screw to reduce range just until the indicator light goes out. This completes set back adjustment.

6.8 ILB SPECIFICATIONS

Range:	100 feet maximum with included reflector
Dead zone:	1 to 10 feet in front of emitter, sensitivity dependent
Operating temperature:	- 40° to 70°C (- 40° to 158°F)
Response time:	1/100 of a second
Enclosure:	Meets NEMA standards 1, 3, 12, and 13
Power consumption:	60mA maximum at 10 to 30 VDC

7.0 ACCESSORIES

Any accessories provided with the Sentinel not found in this manual may be supplied with an instruction sheet if necessary or may be found on our website.

8.0 SHIPPING INFORMATION

Should the need arise to ship a Sentinel back to the factory, a return authorization is required. Contact Karas Technical for this authorization.

When shipping it is recommended that the original packing be used. If this is unavailable, use a cardboard shipping box 16" x 12" x 10" or larger. Packing materials such as styrofoam peanuts or popcorn should be placed all around the Sentinel to the point that it fills the box. Do not use hard packing materials such as styrofoam sheets for this does not cushion the Sentinel from impact.

Ship via United Parcel Service - Ground Service and insure for at least the value of the unit.